

# Compleo eBOX smart Instructions for use

(Generation 3.5)

## Differences between generations 3.0 and 3.5

The new eBOX generation 3.5 builds on the benefits of generation 3.0. Nothing changes for you as a customer.

### The new generation offers you the following additional functions:

- Grid control box integration enables control of the eBOX by the network operator
- LSA terminal replaced with RJ45 socket

### Certificates



As of: 03/2022  
Document Center:



# Content

<b>04</b>	Safety information
<b>06</b>	Product overview
<b>07</b>	Clicking the Compleo eBOX into the Compleo eCLICK
<b>10</b>	Compleo eBOX system configuration
<b>11</b>	Charging process
<b>12</b>	Troubleshooting
<b>14</b>	Specifications
<b>18</b>	Notes
<b>19</b>	Imprint

This document might not contain the latest changes to the product's specifications or processes described herein.

## Safety information

### DANGER

#### Danger to life and limb



Warning of electrical voltage!

### IMPORTANT

#### Considerable risk of injury/ damage to property



IMPORTANT! There is a risk of injury or damage to property!

### NOTE

#### Information on optimising the application



Observing this information can improve the product's application.



#### Danger

Handling live components incorrectly may cause grievous injuries and death. So heed at all times the five safety rules under DIN VDE 0105:

- Disconnect from all power sources
- Lock against reactivation
- Verify zero voltage (all poles)
- Earth and short circuit
- Cover or partition-off adjoining live parts



#### Danger

Turn off circuit before remounting or replacing the eBOX.



#### Important

Technically non-functioning or defective charging infrastructure must not be used. In addition, do not use any charging infrastructure that does not comply with the intended use or the conditions specified by the manufacturer or which is not regularly checked.



#### Important

eBOX bases have sharp edges. Do not grasp the eBOX by the bases.



#### Important

The contents of the delivery must be checked for completeness and intactness.



#### Important

When selecting the installation location, please ensure that the eBOX is not exposed to permanent sunlight.



#### Important

Keep equipment pack away from small children. There is a risk that small parts could be swallowed by children, resulting in death. Do not install in the presence of children.



#### Important

Ensure that no flammable or combustible materials are stored at a distance of less than 5 m from the charging infrastructure and that no fire is lit.



### Important

Ensure that all components are dry during installation.



### Note

This is a CE-certified product. All relevant product standards and rules and regulations applicable to the product are confirmed in the product's EC Declaration of Conformity.



### Important

Check that the warranty seal on the back of the eBOX is intact. Do not operate the product unless the warranty seal is undamaged. Damaged warranty seals void the warranty.



### Note

eBOX smart is a maintenance-free product. It does not contain any reparable parts or components. Do not carry out any repair work. In case of a permanent error, replace the eBOX.

### About this document

These instructions for use contain information on the proper use of eBOX smart (generation 3.5). The eBOX must be handled in accordance with these instructions for use.

Before installing the eBOX, the installation of an eCLICK is required, as the eCLICK serves as a docking station. This pre-installation must be carried out by a qualified electrician and is described in detail in the installation instructions enclosed with the eCLICK.

For complete installation, please refer to the installation instructions mentioned above. Please follow the steps in these instructions for use exactly to ensure your personal safety and the functionality of the eBOX. Do not carry out any work on the eBOX that is not described in these instructions for use. If in doubt, consult an expert.

Furthermore, only use accessories specially manufactured for the eBOX.

### Intended purpose

The instructions for use refer to eBOX smart and are valid for the use of eBOXes within the EU and the United Kingdom. **Please check the country-specific safety standards.**

### Compleo eBOX: intended use

The device is intended for outdoor and indoor use.

In public areas, the operator guarantees that these instructions will be legible permanently. The operation of the eBOX requires knowledge of these instructions.

The device is intended exclusively for charging electric vehicles with type-2 plugs according to IEC 62196-2, with type-1 plug according to SAE J1772-2009 (only possible with alternative eBOX socket version) and charging current control via pilot signal according to IEC 61851-1. For a device without attached charging cable, at least a type-2 plug must be used on the infrastructure side. Use for supplying power to other devices is not permitted.

### Please note:

- Any use of adapters and converters as well as charging cable extensions is prohibited.
- Two protection devices are installed outside of eBOX and eCLICK; both protection devices must be easily accessible.



### Important

It is recommended not to install the eBOX in areas where electromagnetic emissions from large industrial facilities may interfere with communication.

## Product overview

### Included in delivery

- 1 eBOX smart with attached notes for use
- 1 set of instructions for use with attached PUK for Bluetooth

### Compleo eBOX smart – Product details

- 1 Shutter
- 2 Socket/plug compartment
- 3 Type plate
- 4 Notes for use
- 5 LED ring
- 6 Bluetooth pairing button
- 7 Vehicle LED
- 8 Authentication LED
- 9 eCLICK (separate delivery)

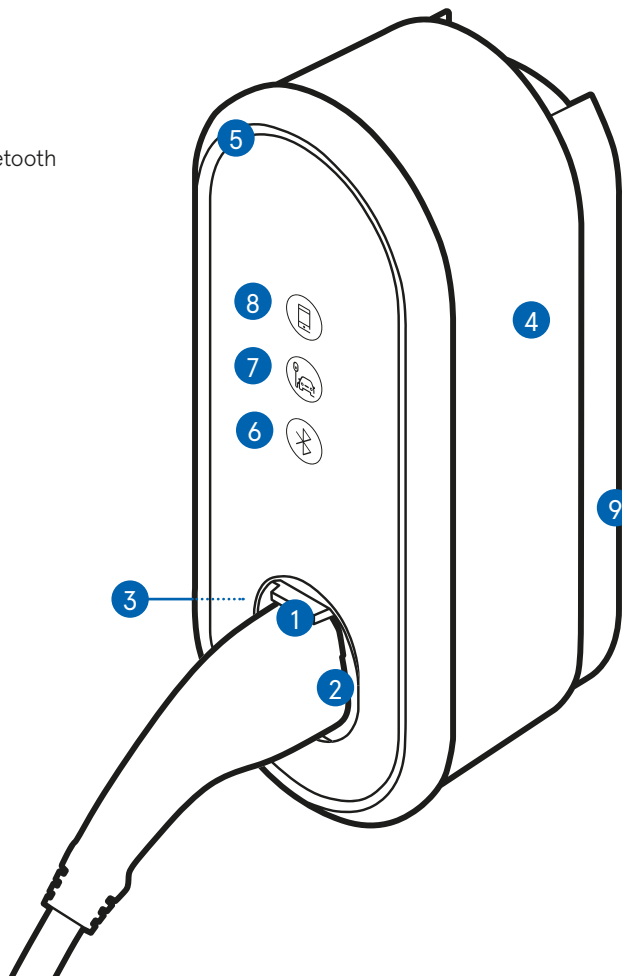

# Clicking the Compleo eBOX into the Compleo eCLICK

Before mounting the eBOX, make sure there is no voltage across the eCLICK.

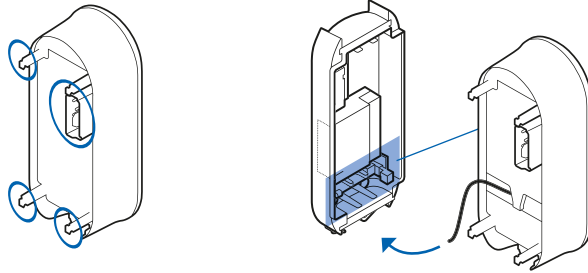

**01** If an eSMARTMETER is installed, make sure the ports are connected to the supplied data cable. Connect port 3a (eSMARTMETER) to port 3b (eCLICK) using the data cable. Take the eBOX and identify the connecting points (blue here) on its rear side.

**02** Connect the black ribbon data cable of the eBOX to port "5 Expansion Terminal" at the bottom right of the eCLICK.

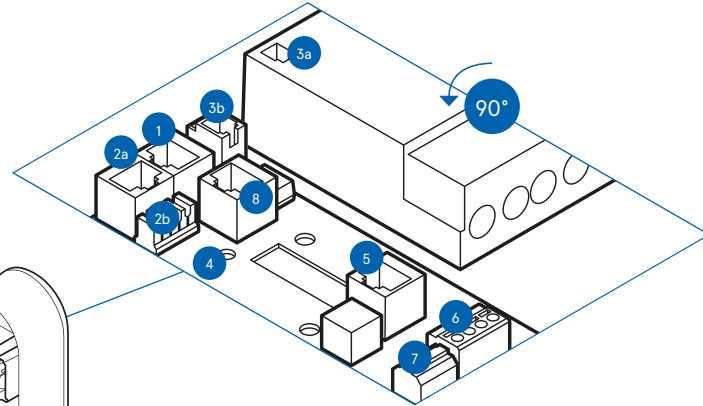

- 1 LAN 3 RJ45 (eBOX communication)
- 2a LAN 2 RJ45 (to Internet router)
- 2b LAN 2 LSA-Plus (to Internet router)
- 3a eSMARTMETER output (optional)
- 3b eSMARTMETER input (optional)
- 4 Cable clip position for S/FTP cable
- 5 RJ50 Terminal (eBOX communication)
- 6 Grid control box connection
- 7 Shunt release connection
- 8 LAN 1 RJ45 (deactivated)

## 8 | Clicking the Compleo eBOX into the Compleo eCLICK



### Important

Make sure that the flat ribbon data cables are not trapped between the eCLICK and eBOX when mounting the eBOX.

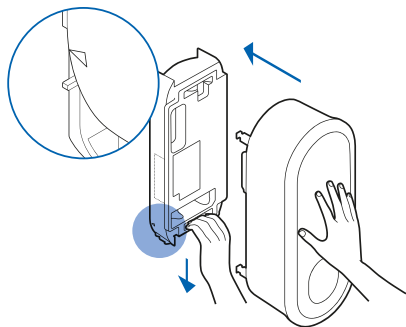

**03**

Please prepare the installation by pulling down the locking bracket completely and ensuring to hold it firmly in this position. Now place the eBOX carefully on the eCLICK and push it firmly in the middle with the other hand until it stops. Be careful not to exert excessive pressure on the circle LEDs.

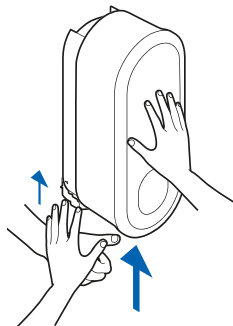

**04**

Now release the bracket and let it lift automatically. Please hold the eBOX in place with one hand.

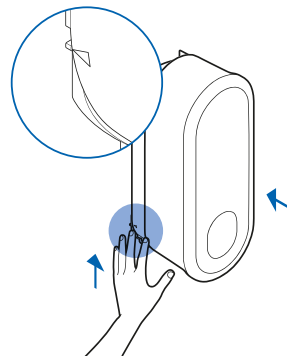

**05**

Please continue to hold the eBOX in place with one hand. Check the final position of the locking bracket, it must be fully raised. The enlarged detail view demonstrates the desired final position. The pin on the locking bracket must be exactly level with the triangle on the eBOX. If the bracket has not reached the desired final position, please push it further upwards to the desired final position.



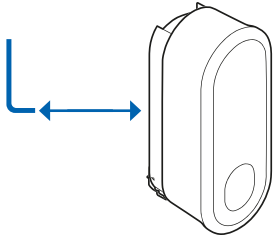

**06**

Tighten the pre-installed grub screw on the eCLICK using the allen wrench to secure the locking mechanism in place and to secure the eBOX on the eCLICK against unauthorised removal.



**Important**

Make sure that the eBOX clicks correctly into the eCLICK. The locking bracket must be in the final position. The grub screw must be fully screwed in. Check eBOX for firm attachment.



**Note**

The grub screw can only be fully screwed in when the locking bracket is inserted completely.

**07**

Now the eBOX is mounted on the eCLICK. Power on the eCLICK circuit.



## Compleo eBOX system configuration

### Note

This product contains antennas that emit electromagnetic fields that can interfere with other electronic devices such as mobile phones and medical devices when exposed to prolonged periods of time at intervals less than 3.5 cm. If prolonged exposure is expected, a minimum distance of 20 cm is recommended to avoid interference.

### Configuration for private use

Technical commissioning and configuration must be **carried out entirely by an electrician**. Have the PUK of your eBOX at hand for this purpose.

You will find the PUK on the back of these instructions for use. **Keep the PUK and the instructions for use in a safe place** and also pass them on to any subsequent owners of the eBOX.

After technical commissioning by the electrician, you as the user can configure, control and manage your eBOX via app.

### You have the option of using the eCHARGE+ app or your provider's app:

#### Via eCHARGE+ app

Please download the eCHARGE+ app from the Apple or Google Play Store. You can configure your eBOX in the menu item "Charge at home". Please follow the instructions in the app.

#### Via third-party app

For details on how to use your provider's app, please contact your eBOX dealer.

### Configuration for commercial use

Technical commissioning and configuration must be **carried out entirely by an electrician**. Use the Compleo eCONFIG app for the configuration for commercial use.

### You have the option of connecting your eBOX to the Compleo backend or a third-party backend of your choice:

#### Via Compleo backend

With your purchase of the eOPERATE software service, your product's system was automatically configured to your specified e-mail address. Please use the eOPERATE portal for any configuration and administration. You have received the initial password by e-mail. If you no longer have it, you can reset your password at [eoperate-portal.com](http://eoperate-portal.com).

#### Via OCPP/third-party backend

Please contact your backend provider if you have any questions about the system configuration.

Would you like to use eCHARGE+ or eCONFIG?  
Download your app:



## Charging process

The charging process consists of connecting your vehicle to the eBOX, authenticating the charging process, charging your vehicle and finally disconnecting your vehicle from the eBOX. Please make sure to carefully stow away any firmly connected cables after use (steps 1 and 2 are interchangeable).

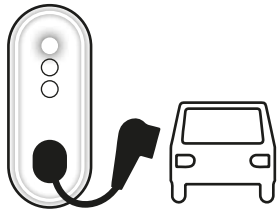

**01**

Connect your electric vehicle to the eBOX. To do this, plug the cable into the eBOX first. Once your car is successfully connected, the vehicle LED will turn off and the LED ring will light up white.

### Proper use of charging cables

No charging cables with adapters of any kind may be used on the eBOX. The use of extension cables is also not permitted.

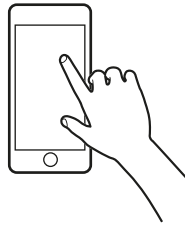

**02**

Authenticate the charging process via (e.g. eCHARGE+ app). To do this, you need the charging point number, which is located on the front of the eBOX. When authentication-free charging has been set, charging starts immediately.

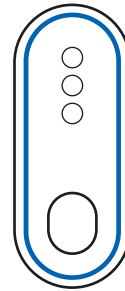

**03**

Shortly after successful authentication, the LED ring will begin to pulse blue and your vehicle will charge. After 10 seconds, the authentication LED turns on again. To save power, the ring is switched off after a few minutes when you move away from the eBOX.

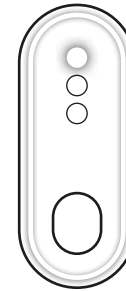

**04**

The charging process is finished\* when the LED ring lights up white again. After you have unlocked the vehicle or the charging process has ended, remove the charging cable, which disconnects the eBOX from the vehicle.

\* Optionally, the charging process can also be ended via app (e.g. eCHARGE+ app).

# Troubleshooting

## Troubleshooting

Most eBOX malfunctions occur due to incorrect operation, which means they cannot be registered by the device and thus cannot be displayed. This includes the following situations, among others:

- No power source connected
- Charging cable connected incorrectly

If a malfunction continues to occur despite following the instructions for use, we recommend restarting the eBOX. To do this, disconnect the eBOX from the power supply for a short time by switching off the circuit breaker in the sub-distribution and then reconnect the eBOX. If necessary, also check the connection at the vehicle.

## Charging process malfunction

In rare cases, the charging process is disrupted or slowed down by external influences. This can occur for the following reasons:

- Overheating of the eBOX:  
The eBOX automatically reduces the charging power when a temperature limit is exceeded, slowing down the charging process temporarily. Therefore, avoid any direct sunlight on the eBOX.



### Note

An additional ventilation option is not provided for the eBOX.

- Charging issue at the vehicle:  
Check the error display of your vehicle.

## Authentication error

- Authentication LED remains on (LED ring flashes red briefly):  
Authentication via app (e.g. eCHARGE+ app) was unsuccessful. Please repeat the authentication process via app.

## Vehicle not connected properly

- Vehicle LED remains on (LED ring does not light up):  
Error in communication between vehicle and eBOX. Check the connection between vehicle and eBOX and reconnect if necessary.

## Faulty Bluetooth connection

- Bluetooth pairing button does not light up:  
Error in Bluetooth communication between the eBOX and your smartphone/tablet (only relevant in private eBOX operation in offline mode). Restart the Bluetooth connection on your smartphone/tablet and on the eBOX by pressing the Bluetooth pairing button.



**Danger**

Device error.  
Warning of electrical  
voltage.

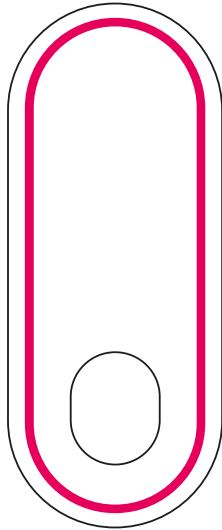

**Critical error**

A serious device fault has rendered the eBOX inoperable, and it must be disconnected immediately from the mains. If the error persists after restarting and cooling down the eBOX, please consult a qualified electrician and initiate eBOX replacement if necessary.

## General specifications

Number of charging points	1
Cable length (in cable version)	6.5m
Charging mode	Mode 3 according to IEC 61851
Areas of application	Indoor and outdoor
IP code of the housing	IP55
Protection class (impact resistance)	IK10 according to IEC 62262:2002
UV protection	Outdoor areas (F1)
Housing material	Copolymer
Storage temperature	-30 °C to +80 °C
Weight	3.1 kg (without cable)/6.4 kg (with cable) (each without eCLICK and without eSMARTMETER)
Packaging dimensions (W x D x H)	515 mm x 225 mm x 235 mm (without cable)/ 695 mm x 370 mm x 235 mm (with cable)
Power consumption in standby mode	6W
Certifications	CE (tested and confirmed by certified body); UKCA
Foliation	Custom film with customer logo available
Charging point number (EVSE ID)	Lasered on shutter

## Working conditions

Operating temperature	-30 °C to +50 °C at full load output Thermal overload protection: output power reduced at higher temperatures
Air humidity	5% to 95% as defined under IEC 61851-1 Ed.3/EN 61851-1 (2017)
Max. altitude above sea level	Max. 2,000 m (air pressure: 860 hPa to 1,060 hPa)
Protection class	Protection class I

## Electrical input/power connection

Input power from eCLICK	Three-phase current 400 V AC, 32 A (22 kW)/20 A (13.8 kW)/16 A (11 kW) Alternating current 230 V AC, one-phase, 32 A (7.4 kW)/20 A (4.6 kW)/16 A (3.7 kW)
Charging power	3.7/4.6/7.4/11/13.8/22 kW (16 A, 20 A, 32 A; one or three-phase)
Output power	Three-phase current 400 V AC, 32 A (22 kW) or 16 A (11 kW) Alternating (one-phase) current 230 V AC, 32 A (7.4 kW) or 16 A (3.7 kW)
Plug assembly	Without charging cable: Type-2 plug assembly as defined under DIN EN 62196-2 with automatic plug locking, shutter With charging cable: Type-2 plug as defined under DIN EN 62196-2, plug compartment on eBOX, shutter
Consumption measuring	Electricity meter eSMARTMETER: optional for eCLICK, MID-compliant (Europe) and CE-certified

## Protective equipment

DC fault current monitoring (personal protection)	Integrated all-current sensitive current monitor (GFCI) for DC fault monitoring, response value: DC 6 mA
Welding detection (indication signal for welded power contacts)	Connection via change-over contact (max. 230 V, 1 A), use e.g. for shunt release for disconnection of main power path
Integrated overvoltage protection	According to IEC 61851-21-2:2018 (ESD/surge/burst)

## Communication

Vehicle communication	Charging current controlled via PWM pilot signal in accordance with IEC 61851-1:2017
Direct communication	Bluetooth Class 1 and 2 (power level)
Backend connectivity	Via OCPP 1.6J to Compleo backend or third-party backends
Backend communication	WLAN with 2.4 GHz IEEE 802.11 b/g/n with WPA2 (antenna gain, frequency-dependent, max. 4.6 dBi)

## Authentication

Authentication	Free charging, smartphone app (eCHARGE+ app/third-party apps) via contract charging or direct payment via <a href="https://www.powerdirect.com">epowdirect.com</a>
----------------	--



## UI/UX

---

Display/interaction	LED ring for charging status; 2 LED indicators for authentication and vehicle connection status, 1 LED button for Bluetooth connection
Notes for use	Attached to the side of the eBOX as a graphic

## External accessories

---

Personal protection to be installed in sub-distribution	Fault current protection switch type A (RCD type A): 32A connection: ABB F204A-40/0.03, type A, 4-pole (short-time delay, operating voltage: 230/400 V AC) 16A connection: ABB F204A-25/0.03, type A, 4-pole (short-time delay, operating voltage: 230/400 V AC)
Short-circuit/overload protection to be installed in sub-distribution	Circuit breaker: 32A connection: ABB S203-NA K40A (rated switching capacity: 6,000 A) 16A connection: ABB S203-NA K20A (rated switching capacity: 6,000 A)

## Notes

**The product eBOX smart must always be used in conjunction with the eCLICK.**

Electric vehicle charger characteristics according to IEC 61851-1 Ed. 3:

1. The product must be connected to an AC mains.
2. The product is connected permanently to the mains.
3. The product is eCLICK-compatible.  
It is available in the variants with a type-2 socket and with a type-2 plug with attached cable.
4. The product is compatible with electric vehicles charged with AC in mode 3.
5. The product can be installed and used in protected indoor areas and unprotected outdoor areas exposed to rain and direct sunlight.

6. The product can be used in closed-off and public areas.

7. The product can be installed on walls and in compatible Pole products.

8. The product eBOX smart in conjunction with the eCLICK or coverage is rated electrical protection class I.  
The open eCLICK is rated electrical protection class I.

### Maintenance/repair

The eBOX is a maintenance-free product. It does not contain any repairable parts or components. Do not carry out any repair work. In case of a permanent error, replace the eBOX.

### Disposal

The eCLICK and the eBOX are electrical devices. These must be disposed of accordingly in compliance with EU Directive WEEE II, the ElektroG of 20 October 2015 in Germany, or the VREG, SR 814.620, of 14 January 1998 in Switzerland.

### Cleaning

The eBOX may only be cleaned with water; the use of lukewarm water is recommended. Do not use any cleaning agents containing solvents.

### Disassembly

To disassemble the eBOX, you first have to disconnect the power supply. First unscrew the grub screw on the side and remove the eBOX from the eCLICK by pulling down the locking bracket, removing the charging unit and, if necessary, the Ethernet cables which connect the eBOX and the eCLICK.



### Danger

The eCLICK must be disconnected from the power supply before disassembly. Make sure that all components are dry during disassembly.

# Imprint

Copyright © 2022 Compleo Charging Technologies GmbH. All rights reserved.

This document is intellectual property right- and copyright-protected. No part hereof may be edited, duplicated, or published in any manner purposing other than the proper use of the eBOX without express written permission of Compleo Charging Technologies GmbH.

## **Compleo Charging Technologies GmbH**

Oberste-Wilms-Straße 15a  
D-44309 Dortmund  
Germany

Head office: Dortmund, Germany  
Registered as a company at  
Dortmund Local Court,  
Handelsregister-Nr. HRB 30359



## **Compleo Charging Technologies GmbH**

Oberste-Wilms-Straße 15a  
D-44309 Dortmund | Germany

[servicedesk@compleo-cs.com](mailto:servicedesk@compleo-cs.com)  
[compleo-cs.com](https://compleo-cs.com)

## **UK sales partner**

Compleo Charging Solutions UK Limited  
6th Floor | 60 Gracechurch Street  
London | EC3V 0HR | Great Britain